

Soft Sheer Vertical

Installation and Care Guide

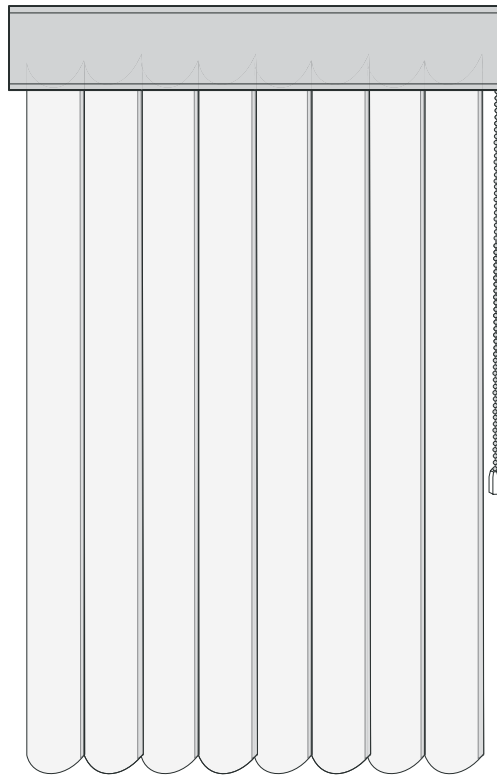

Soft Sheer Vertical Blinds represent a design breakthrough in style, efficiency and function. The unique fabric structure and hardware system are designed to provide years of reliable service when properly installed.

Please take a few minutes to read through these instructions before beginning.

Keep these instructions for future reference

Table of Contents

I Basics	Page 4
II Hardware	
A. Blinds with valance	Page 5
B. Blinds with wood fascia	Page 5
III Bracket Installation	
A. Blinds with valance	
1. Inside Mount	Page 6
2. Outside Mount	Page 6
3. Side Mount	Page 6
B. Blinds with wood fascia	
1. Inside Mount	Page 7
2. Outside Mount	Page 7
3. Side Mount	Page 7
IV Track Installation	Page 8
V Cord Tensioner Installation	Page 8
VI Cord Length Adjustment	
A. Side Stack	Page 9
B. Split Stack	Page 9
VII Vane Installation	
A. Vane Color Facing Right Blinds	
1. Side Stack	Pages 10-12
2. Split Stack	Pages 13
B. Vane Color Facing Left Blinds	
1. Side Stack	Pages 14-16
2. Split Stack	Pages 17
VIII Vane Removal	Page 18
IX Top Treatment Installation	
A. Valance	Page 18
B. Wood Fascia	Page 19
X Cleaning and Care	Page 19
XI Trouble Shooting	Page 20

Options

Soft Sheer Verticals are available with two different top treatments - valance or wood fascia. Soft Sheer Verticals may be ordered with the vane color facing the right or the left. Tracks may be side stack or split stack. Determine which options you have before beginning installation by reading the packing list. Additionally, color right vanes will be labeled with orange, gray, pink, and blue tags. Color left vanes will be labeled with red, yellow, lavender, and green tags.

I BASICS

A few simple tools are required:

- Measuring tape
- Power drill, drill bits
- Hex head and/or Phillips driver bit
- Pencil

Additional fasteners other than those sent with your blind may be required depending on the mounting surface. Wallboard and plaster require the use of anchors such as expansion or toggle bolts. Brick, tile or stone need special plugs and drill bits. Remember to always pre-drill holes in wood to avoid splitting.

II HARDWARE

A. Blinds with Valance

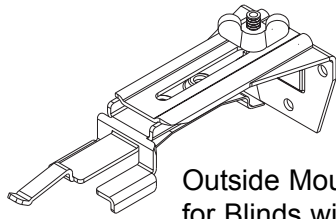

Outside Mount Bracket for Blinds with Valance

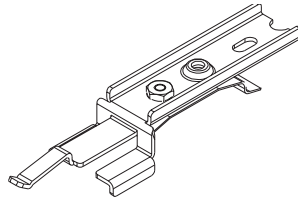

Inside Mount Bracket for Blinds with Valance

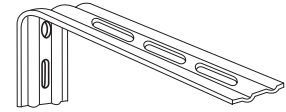

Extension Bracket (used for Side Mounting)



1 1/4" Hex Head



3/4" Round Head Tensioner Screw

B. Blinds with Wood Fascia

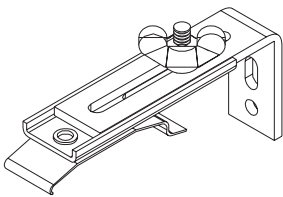

Outside Mount Bracket for Blinds with Fascia

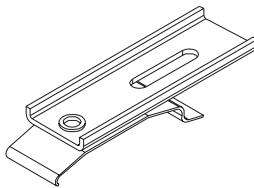

Inside Mount Bracket for Blinds with Fascia

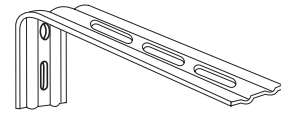

Extension Bracket (used for Side Mounting)



1 1/4" Hex Head



3/4" Round Head Tensioner Screw

III BRACKET INSTALLATION

Basics

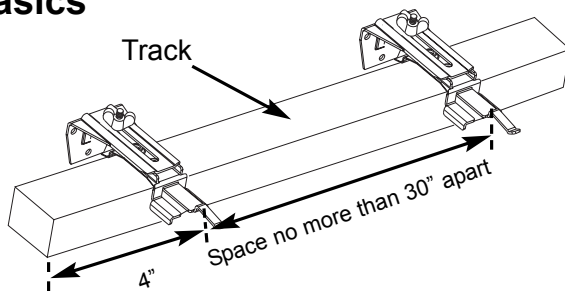

Choose the appropriate mounting option for your application. End brackets should be located with centerlines 4" in from each end. Additional brackets should be spaced no more than 30" apart.

The mounting surface must be level for the vertical to operate correctly. The brackets may need to be shimmed for out of level windows.

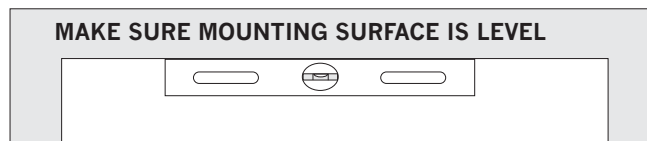

III BRACKET INSTALLATION

A. Blinds with Valance

1. Inside Mount

The back of the mounting bracket must be 1/8" from any obstruction.

Temporarily rotate mounting clip to install second screw. When repositioning the clip, make sure that the rivet used to attach the clip is all the way to the back of the slot.

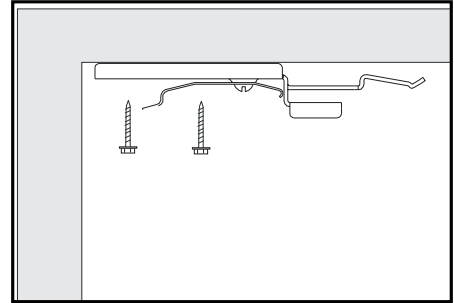

2. Outside Mount

A mounting surface of at least 1 3/4" is required for an OB or wall mount.

Assemble the mounting bracket with the wing nut and bolt provided.

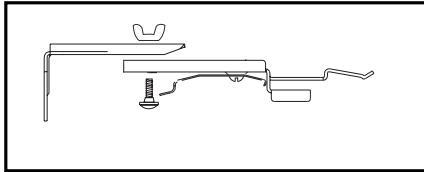
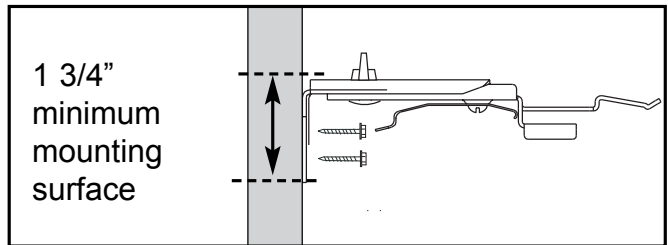

Place the wing nut up, so that it does not interfere with the mounting clip.

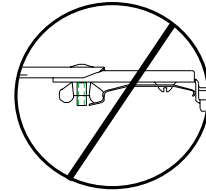

Position the top surface of the mounting bracket at the desired height. Secure bracket to the mounting surface with two screws. Make sure that all brackets are aligned and level.

If mounting above a molding or other possible obstructions, loosen the wing nut and adjust the bracket to project the mounting bracket beyond the obstruction. This will ensure that the sheer fabric and vanes do not hit or rub the obstruction. Brackets will adjust to project the blind up to 1 3/4".

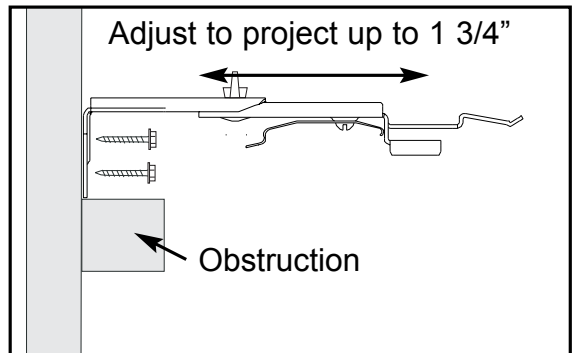

3. Side Mount

Bolt an inside mount bracket to an extension bracket as shown.

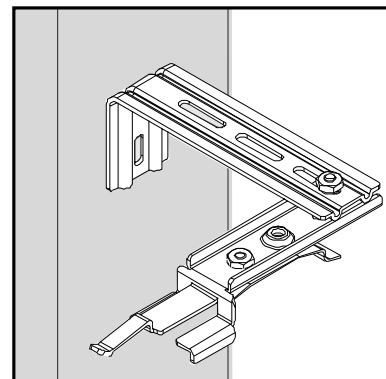

III Bracket Installation

B. Blinds with Fascia

1. Inside Mount

The back of the mounting bracket must be 1/8" from any obstruction.

Temporarily rotate mounting clip to install second screw. When repositioning the clip, make sure that the rivet used to attach the clip is all the way to the back of the slot.

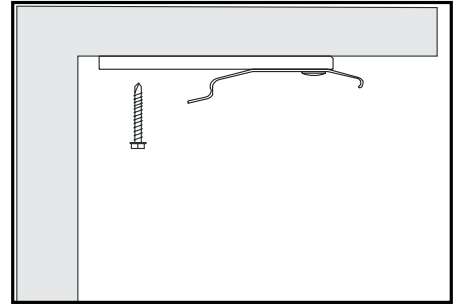

2. Outside Mount

A mounting surface of at least 1 3/4" is required for an OB or wall mount.

Assemble the mounting bracket with the wing nut and bolt provided.

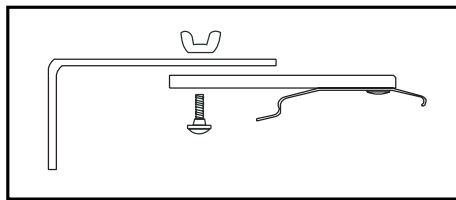
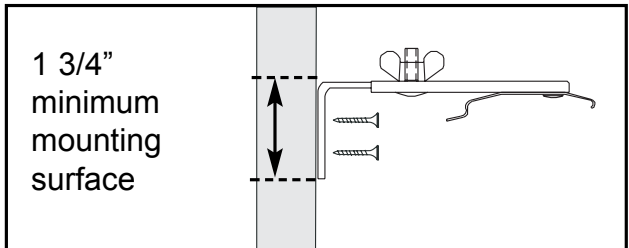

Place the wing nut up, so that it does not interfere with the mounting clip.

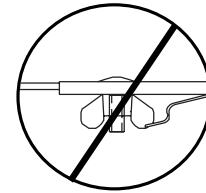

Position the top surface of the mounting bracket at the desired height. Secure bracket to the mounting surface with two screws. Make sure that all brackets are aligned and level.

If mounting above a molding or other possible obstructions, loosen the wing nut and adjust the bracket to project the mounting bracket beyond the obstruction. This will ensure that the sheer fabric and vanes do not hit or rub the obstruction. Brackets will adjust to project the blind up to 1 1/2".

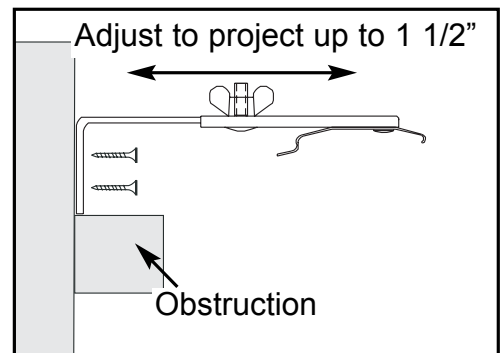

3. Side Mount

Bolt an inside mount bracket to an extension bracket as shown.

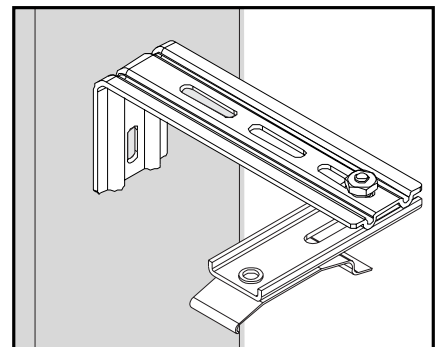

IV TRACK INSTALLATION

Insert the front groove of the track into the front of the mounting clip, then push the back of the rail up to snap into the back of the mounting clip.

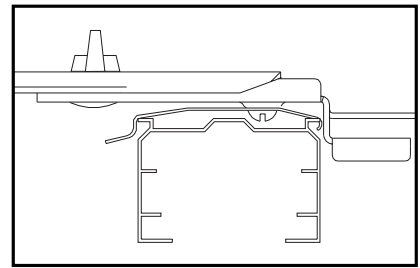
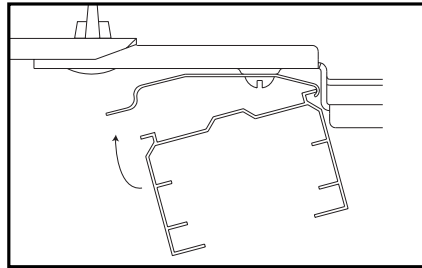

V CORD TENSIONER INSTALLATION

The cord tensioning device is necessary for child safety and for proper operation of the blind. The cord may drop from the track if the tensioner is not installed.

1) Choose the best mounting location for the specific installation.

The tensioning device may be mounted to the sill, to the jamb or to the wall.

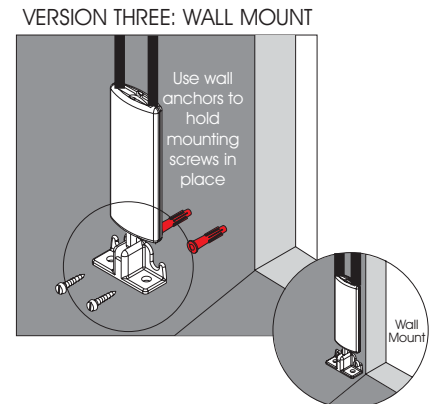
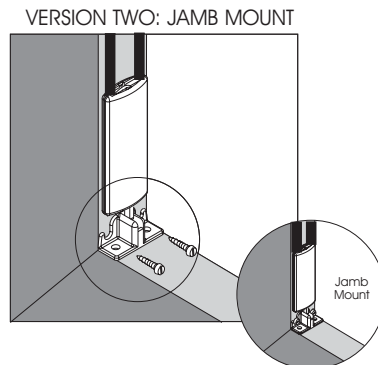
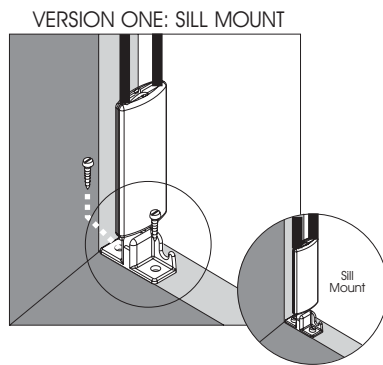

2) Fully extend tensioning device. Lock into extended position by rotating the post 45 degrees.

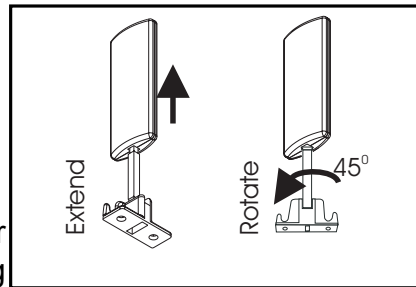

3) Hold the cord tensioner at the desired mounting position with the cord taut and the cord tensioning device in extended position. Screw the tensioning device to the mounting surface. If the specific installation requires that the cord tensioning device be placed in a position so that there is not tension on the cord, the cord length will need to be adjusted (see Cord Adjustment on page 9).

4) Rotate and release cord tensioning post.

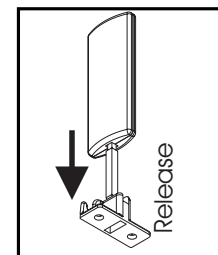

VI CORD LENGTH ADJUSTMENT

If the cord droops from the track or if the cord is not taut when the tensioning device is installed, the cord length will need to be adjusted.

A. Side Stack

To reduce cord length on Side Stack:

1) Operate the track so that the carriers are in the stacked position.

2) Locate 1/2" cord tail in front of lead carrier.

3) Loosen adjusting screw, just enough to be able to pull the cord. If loosened too much the other cord may slip out of position.

4) Pull cord tail until the cord has the proper tension.

5) Tighten adjusting screw. Make sure to tighten enough to prevent the cords from slipping.

6) Cut excess cord.

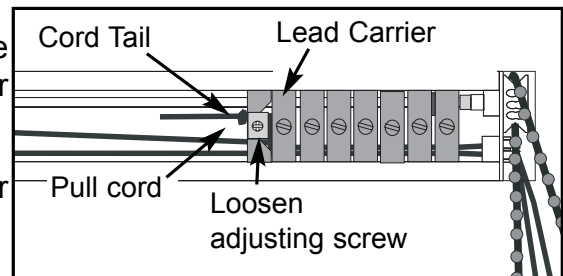
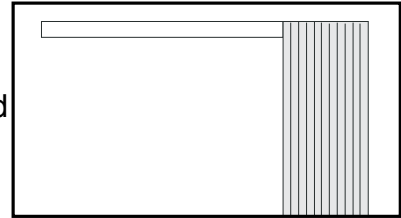

B. Split Stack

To reduce cord length on Split Stack:

1) Place the carriers in the closed position.

2) Locate cord tails in front of lead carrier on the side of the track opposite the control.

3) Loosen adjusting screw, just enough to be able to pull the cord. If loosened too much the other cord may slip out of position.

4) Select a 1/2" cord tail and pull slightly. If any carrier movement is observed **stop**. Select the other cord. Caution - cutting wrong cord will cause irreparable damage.

5) Pull the cord tail until the cord has the proper tension.

6) Tighten the adjusting screw. Make sure to tighten enough to prevent the cords from slipping.

7) Cut excess cord.

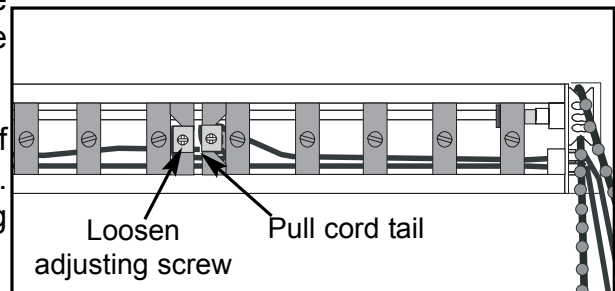
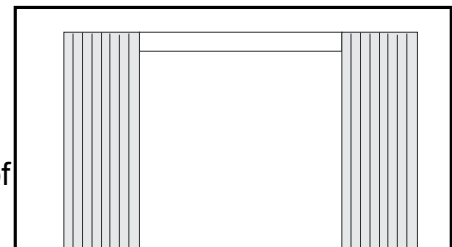

VII VANE INSTALLATION

A. Vane Color Facing Right

INSTALL VANES FROM LEFT TO RIGHT, REGARDLESS OF CONTROL POSITION OR WHETHER BLIND IS SIDE STACK OR SPLIT STACK.

If removal of the vanes are necessary during the installation process see section VIII for the proper removal procedure.

1. Side Stack

VANE CONFIGURATION - Top View



To avoid confusion:
Do not remove vanes tags until
you are ready to install

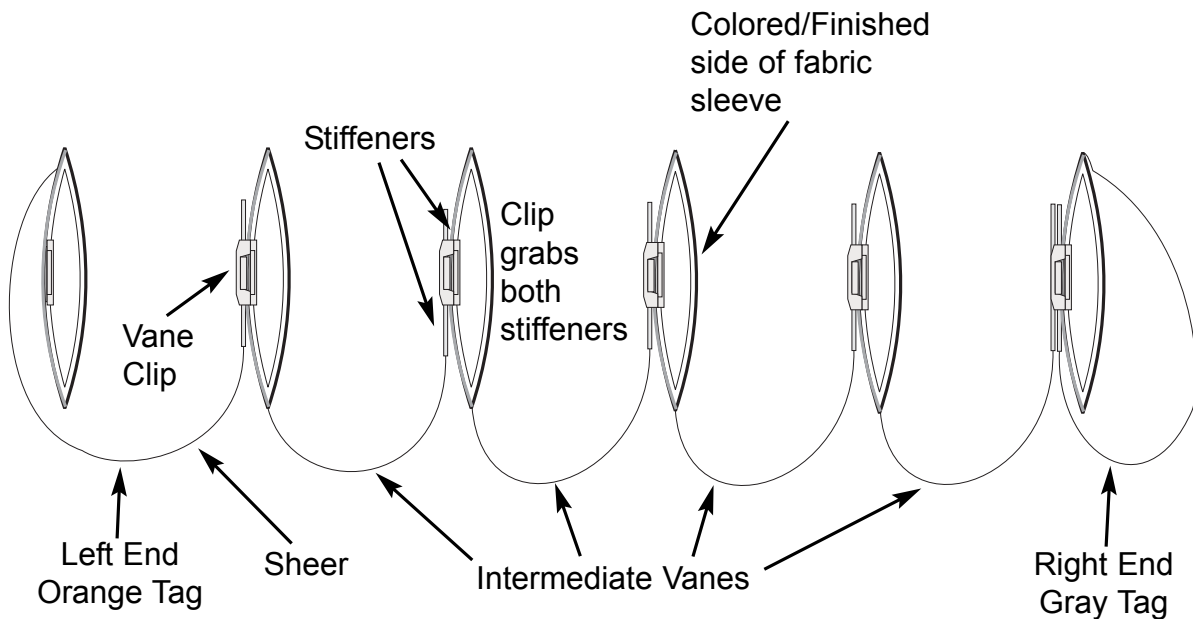

VII VANE INSTALLATION

A. Vane Color Facing Right

1. Side Stack (continued)

Left Vane Attachment:

1) Remove the vane with the ORANGE tag labeled "left vane" from the box. Insert the vane clip into the furthest left carrier.

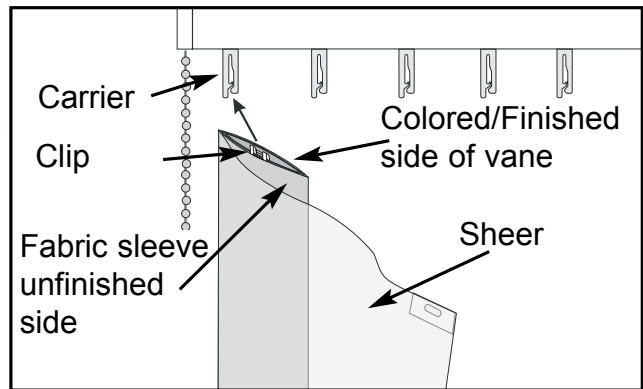
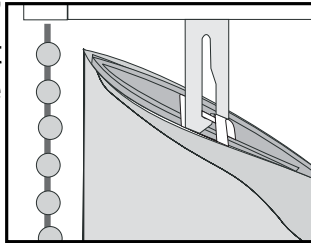

2) Attach all intermediate vanes, leaving the last carrier empty.

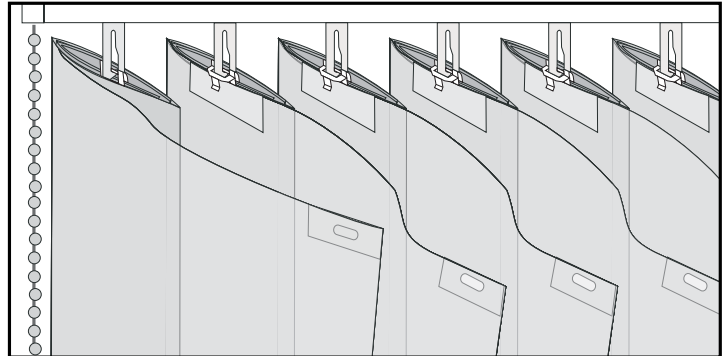

Right Vane Attachment:

3) Remove the vane with the GRAY tag labeled "right vane" from the box. Lay the vane flat on a table with the clip facing up. Fold the top part of the sheer over (Fig. 1). The top piece of Scotch-Mate should lie underneath the clip (Fig. 2). Slide the top Scotch-Mate under the clip (Fig. 3). Holding the end of the Scotch-Mate. Slide the Scotch-Mate through the clip (Fig. 4). Lay the Scotch-Mate down on the small piece of Scotch-Mate. Make sure the Scotch-Mate pieces are aligned and even (Fig. 5). Fold over bottom sheer and line up the bottom Scotch-Mate pieces (Fig. 6).

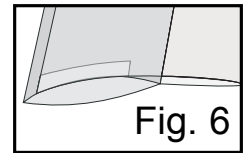
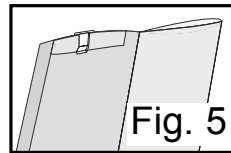
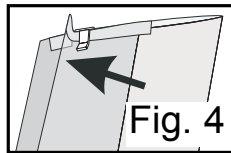
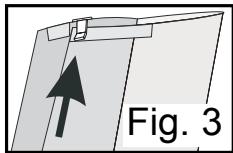
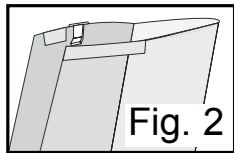
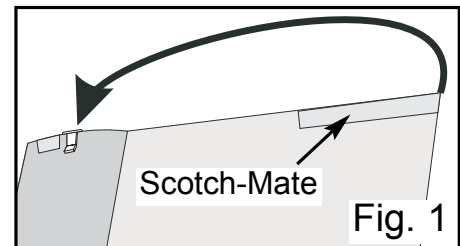

Clip in last vane into the last carrier (Fig. 7).

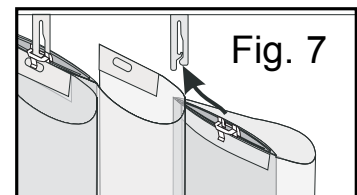

VII VANE INSTALLATION

A. Vane Color Facing Right

1. Side Stack (continued)

4) Insert the stiffener on the sheer portion of the vane under the next vane's clip. Repeat for all vanes.

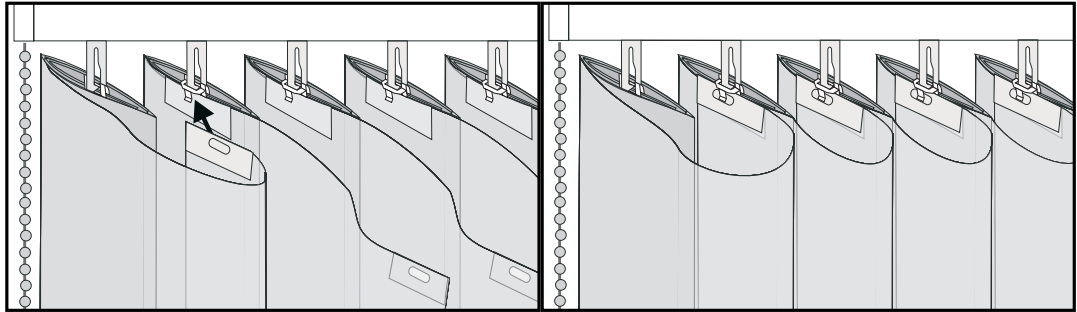

Vane to Sheer Bottom Attachment:

5) Match the pieces of Scotch-Mate at the bottom of each vane. There is one piece of Scotch-mate at the bottom of each fabric sleeve, and sheer. The sheer should be pulled taut to ensure a smooth sheer face without wrinkles or dimples. **The sheer should be taut but not stretched.** The sheer on the LEFT and RIGHT vanes does not extend all the way to the back of the fabric sleeve. The Scotch-Mate should be set with the sheer approximately 1/2" from the edge of the fabric sleeve. On all other vanes the Scotch-Mate should be set so that the edge of the sheer is near the edge of the fabric sleeve.

The Scotch-Mate pieces may need to be offset in the vertical direction (A) slightly to ensure a smooth sheer face. Repeat this step all the way across the width of the blind at every vane until entire blind looks smooth and even. Rotate vanes to the closed position. Check to see that the vanes consistently overlap each other without large gaps. If gaps do occur re-adjust Scotch-Mate in the horizontal direction (B).

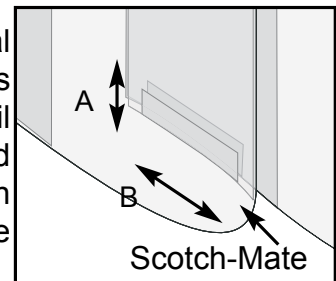

VII VANE INSTALLATION

A. Vane Color Facing Right

2. Split Stack



VANE CONFIGURATION - Top View

To avoid confusion:
Do not remove vanes tags until you are ready to install

Clip
grabs all
stiffeners

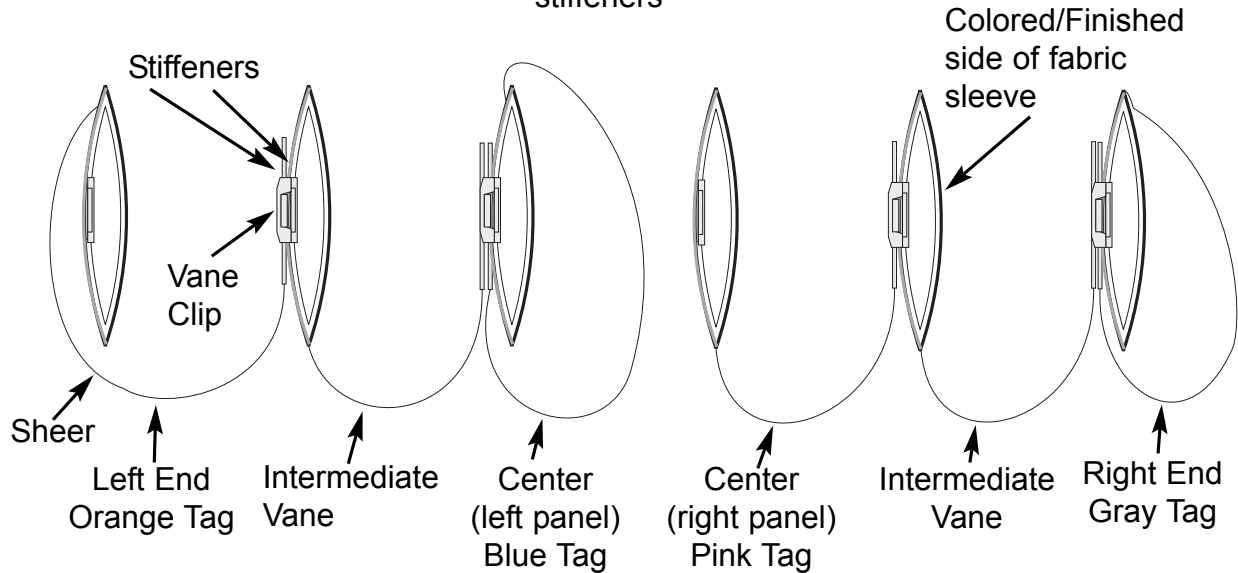

Vane & Sheer Carrier Attachment

Left Panel: Remove the vane with the ORANGE tag labeled “left vane” from the box. Attach the vane following the procedure described in **Step 1** of Side Stack installation. Attach all intermediate vanes following **Step 2** of Side Stack installation, until the right end of the Left Panel is the last one to install. Remove the vane with the BLUE tag labeled “center vane (left panel)” from the box. Follow **Step 3 and 4** of Side Stack installation for attachment procedures, except use the vane with the blue tag.

Right Panel: Follow the same procedure as for the Left Panel. The first vane will have a PINK tag labeled “center vane (right panel)”, the last vane will have a GRAY tag labeled “right vane”. Note: that the “center (right panel)” vane will install the same as an intermediate vane.

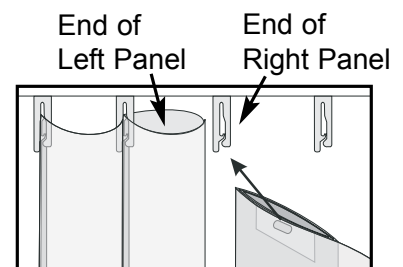

Fabric Sleeve to Sheer Bottom Attachment:

Follow bottom attachment procedures for Side Stack blinds (**Step 5**).

VII VANE INSTALLATION

B. Vane Color Facing Left

INSTALL VANES FROM RIGHT TO LEFT, REGARDLESS OF CONTROL POSITION OR WHETHER BLIND IS SIDE STACK OR SPLIT STACK.

If removal of the vanes are necessary during the installation process see section VIII for the proper removal procedure.

1. Side Stack

VANE CONFIGURATION - Top View

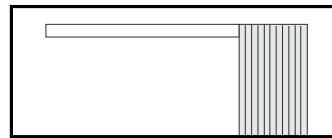

To avoid confusion:
Do not remove vanes tags until
you are ready to install

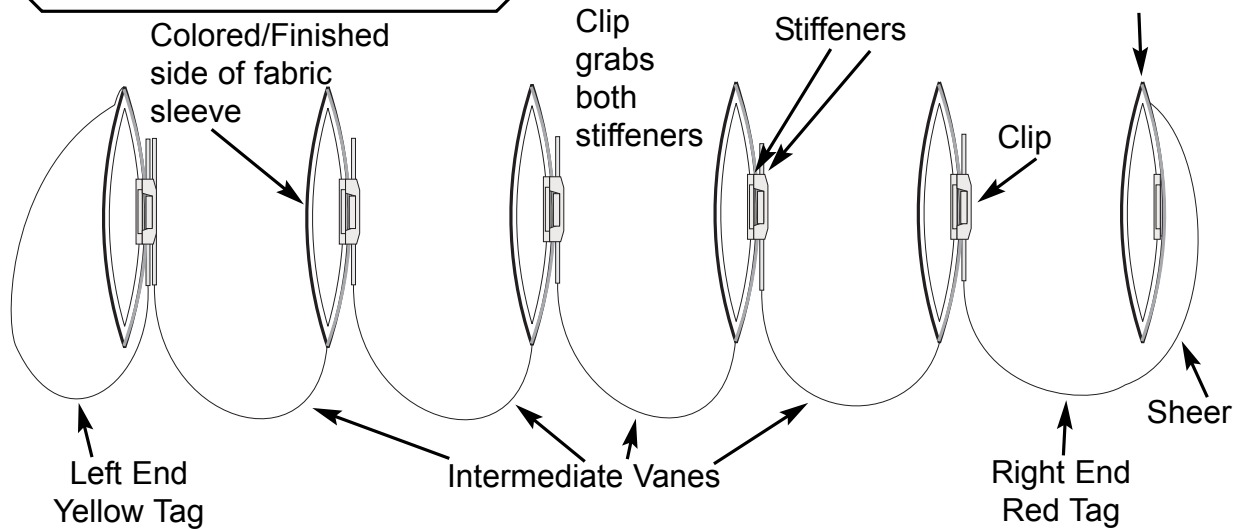

VII VANE INSTALLATION

B. Vane Color Facing Left

1. Side Stack (continued)

Left Vane Attachment:

1) Remove the vane with the RED tag labeled "left vane" from the box. Insert the vane clip into the furthest left carrier.

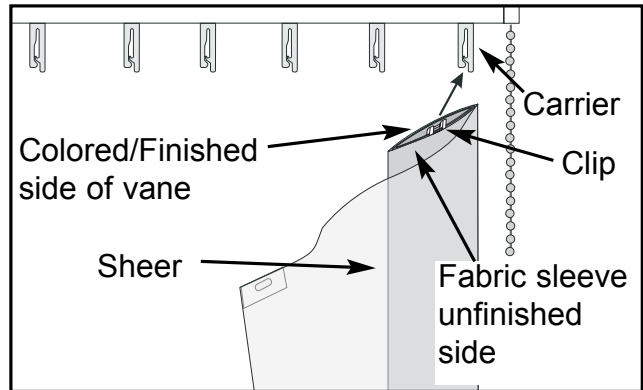
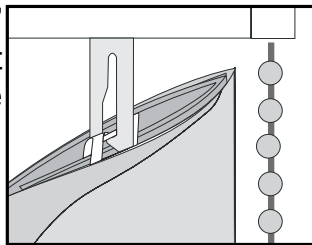

2) Attach all intermediate vanes, leaving the last carrier empty.

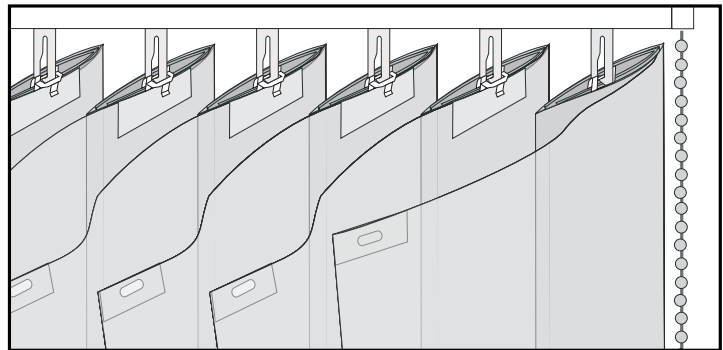

Right Vane Attachment:

3) Remove the vane with the YELLOW tag labeled "right vane" from the box. Lay the vane flat on a table with the clip facing up. Fold the top part of the sheer over (Fig. 1). The top piece of Scotch-Mate should lie underneath the clip (Fig. 2). Slide the top Scotch-Mate under the clip (Fig. 3). Holding the end of the Scotch-Mate. Slide the Scotch-Mate through the clip (Fig. 4). Lay the Scotch-Mate down on the small piece of Scotch-Mate. Make sure the Scotch-Mate pieces are aligned and even (Fig. 5). Fold over bottom sheer and line up the bottom Scotch-Mate pieces (Fig. 6).

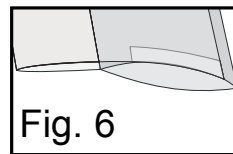
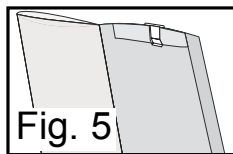
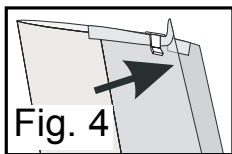
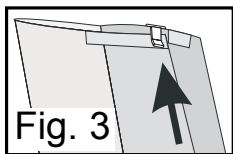
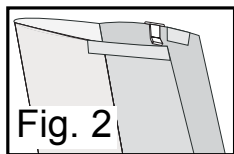
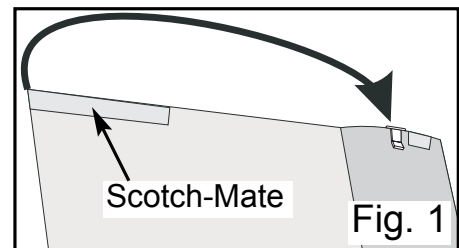

Clip in last vane into the last carrier (Fig. 7).

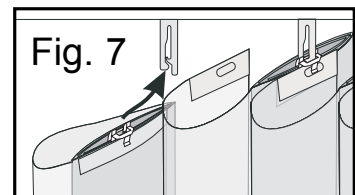

VII VANE INSTALLATION

B. Vane Color Facing Left

1. Side Stack (continued)

4) Insert the stiffener on the sheer portion of the vane under the next vane's clip. Repeat for all vanes.

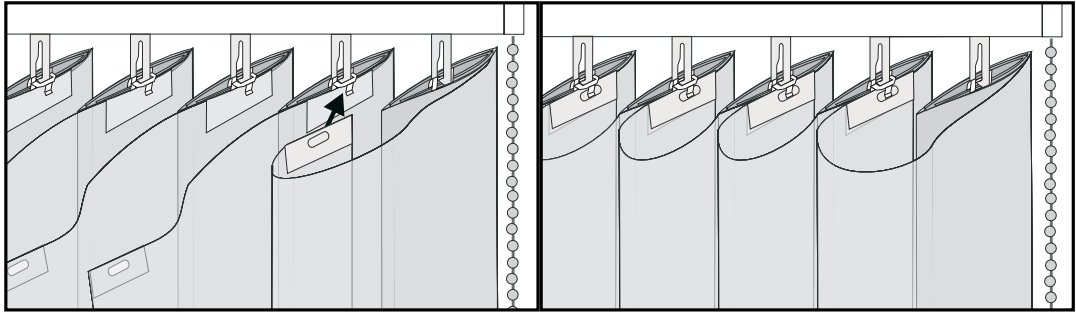

5) Vane to Sheer Bottom Attachment: Match the pieces of Scotch-Mate at the bottom of each vane. There is one piece of Scotch-Mate at the bottom of each fabric sleeve, and sheer. The sheer should be pulled taut to ensure a smooth sheer face without wrinkles or dimples. **The sheer should be taut but not stretched.** The sheer on the RIGHT and LEFT vanes will not go all the way to the back of the fabric sleeve. The Scotch-Mate should be set with the sheer approximately 1/2" from the edge of the fabric sleeve. On all other vanes the Scotch-Mate should be set so that the edge of the sheer is near the edge of the fabric sleeve.

The Scotch-Mate pieces may need to be offset in the vertical direction (A) slightly to ensure a smooth sheer face. Repeat this step all the way across the width of the blind at every vane until entire blind looks smooth and even. Rotate vanes to the closed position. Check to see that the vanes consistently overlap each other without large gaps. If gaps do occur re-adjust Scotch-Mate in the horizontal direction (B).

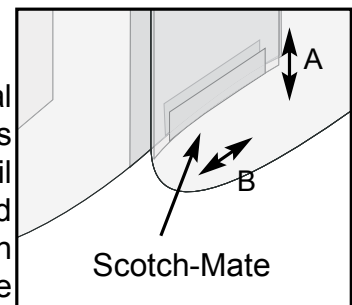

VII VANE INSTALLATION

B. Vane Color Facing Left

2. Split Stack

VANE CONFIGURATION - Top View



To avoid confusion:
Do not remove vanes tags until you are ready to install

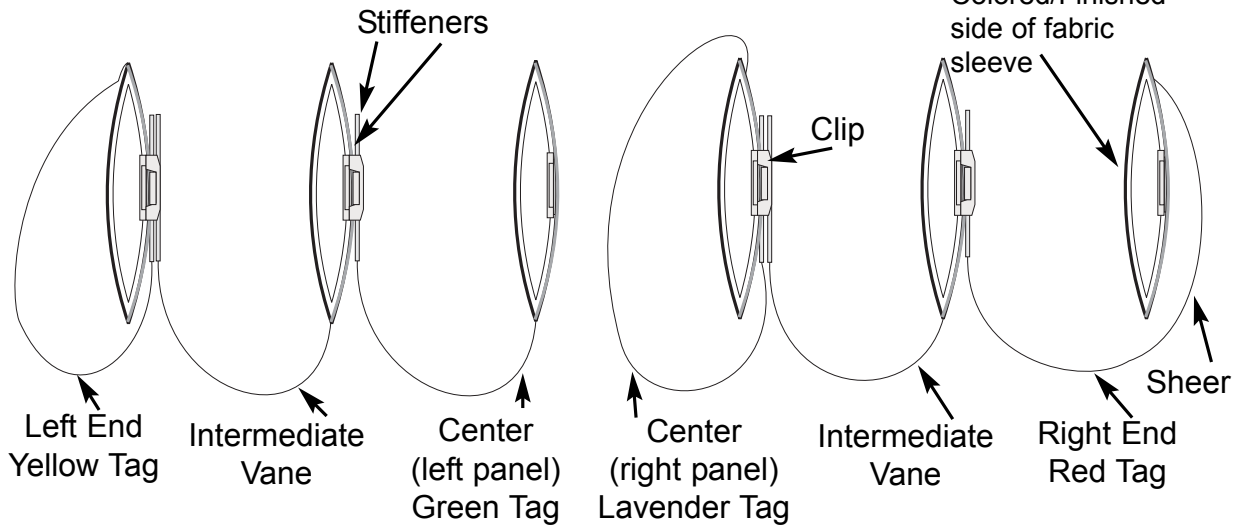

Vane & Sheer Carrier Attachment

Right Panel: Always start vane installation at the carrier furthest to the right. Remove the vane with the RED tag labeled “right vane” from the box. Attach the vane following the procedure described in **Step 1** of Side Stack installation. Attach all intermediate vanes following **Step 2** of Side Stack installation, until the left end of the Right Panel is the last one to install. Remove the vane with the LAVENDER tag labeled “center vane (right panel)” from the box. Follow **Step 3 and 4** of Side Stack installation for attachment procedures, except use the vane with the blue tag.

Left Panel: Follow the same procedure as for the Left Panel. The first vane will have a GREEN tag labeled “center vane (left panel)”, the last vane will have a YELLOW tag labeled “left vane”. **Note:** that the “center (left panel)” vane will install the same as an intermediate vane.

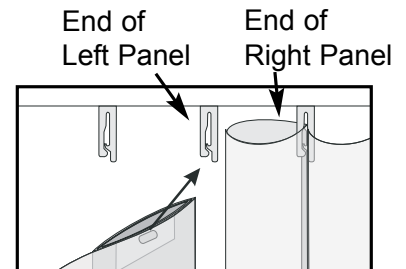

Fabric Sleeve to Sheer Bottom Attachment:

Follow bottom attachment procedures for Side Stack blinds (**Step 5**).

VIII REMOVAL OF VANES FROM CARRIERS

(These steps are needed only if a vane needs to be repositioned during install or for cleaning, or replacement)

Sheer Removal

Peel back Scotch-Mate on bottom of all the vanes. Using a credit card slide the card under the clip on top and slide out sheer stiffener.

Vane Removal

Grasp vane and vane clip.

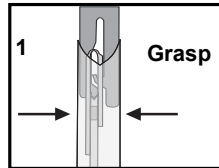

Tilt vane clip so that the top of the clip pushes against the short side of the carrier stem. You should hear an audible click.

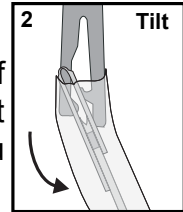

Vane Insert Removal

The Vane Inserts can only be removed when the full Vane is unattached from the carriers. Lay the full Vane on a flat surface with the clip facing up. Gently detach the Dual-Lock at the top of the vane, and slide the plastic insert out from the top of the fabric sleeve pocket.

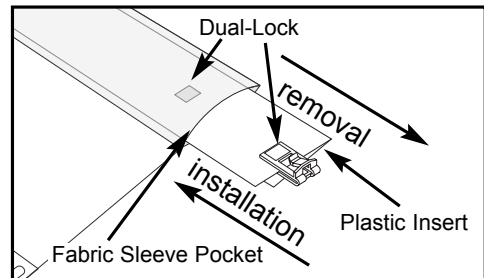

Vane Insert Installation

Slide the bottom end of the plastic insert into the top of the pocket of the fabric sleeve. Place the bottom corners of the vane clip crossbar at the top of the fabric sleeve (Dual-Lock halves should align). Press the two halves of the Dual-Lock together. Set the fabric sleeve under the vane clip.

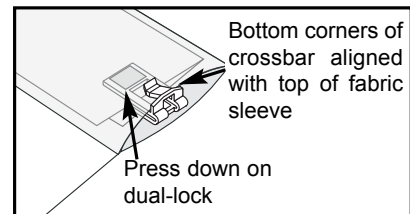

IX TOP TREATMENT

A. VALANCE

Do not remove protective film until installation is complete. Install the track and vanes before attaching the valance

1. Assembly

If valance comes with returns, snap the return labeled *Right* onto the right end of the valance. snap the return labeled *Left* onto the left end of the valance.

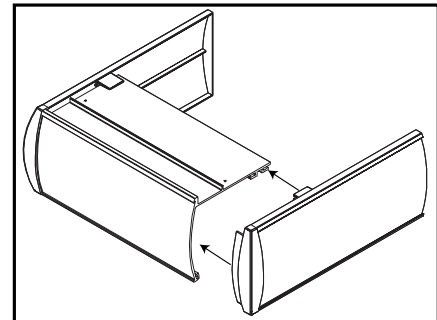

2. Installation

Hold valance in front of the Soft Sheer Vertical and position where desired horizontally.

The back of the flat-top of the valance will be inserted into the front of the bracket. Once the valance is aligned properly insert the edge into the bracket and press firmly until the edge of the valance is all the way in.

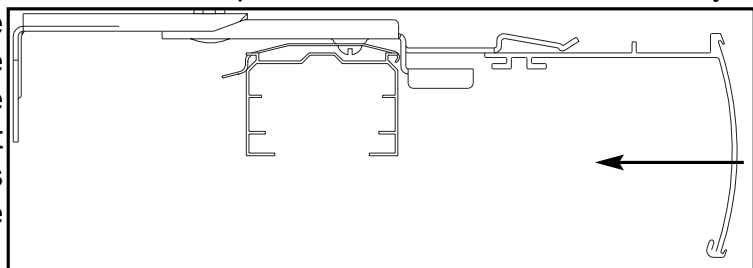

IX TOP TREATMENT (continued)

B. Wood Fascia (Outside Mount)

Install the track before attaching the fascia. Attach the fascia to the track as shown.

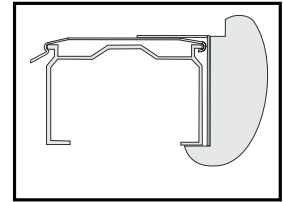
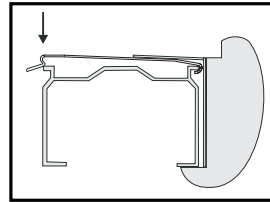
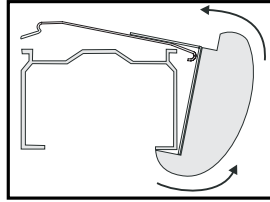

B. Wood Fascia (Inside Mount)

Install the track before attaching the fascia.

Hold the fascia in position. Press the Dual-Lock pieces on the back of the Fascia to the Dual-Lock on the track.

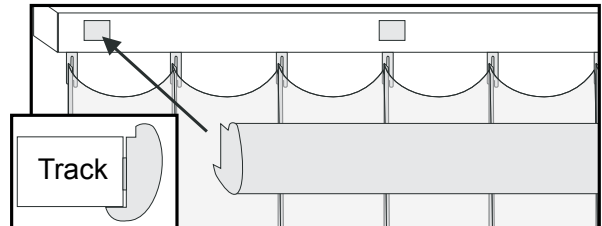

X CLEANING & CARE

The sheer fabric may temporarily appear wrinkled upon initial installation. Although we package the vanes carefully, wrinkles sometimes occur during shipping. The wrinkles will dissipate over a short period of time. If you do not see an improvement after 24 hours, or the wrinkles are severe, you can steam the sheer. When steaming, the head of the steamer may come in contact with the sheer for up to 3 minutes.

All parts of the Soft Sheer Vertical can be cleaned with a feather duster or a standard vacuum. We recommend doing either of the two regularly to keep your Soft Sheer Vertical looking new.

Spills and stains can be lightly blotted with a cloth or damp sponge. More difficult stains may require gentle washing in water with mild soap. For this, remove the vanes from the carriers (see section VIII), remove the inserts from the vane pocket and submerge, soak and rub lightly. Lay flat to dry or place back in window.

To iron or fully wash the vanes, remove the vanes from the carriers (see section VIII). Remove the plastic inserts from the pocket of the fabric sleeves (see section VIII).

The sheer fabric and the colored fabric sleeve can be ironed if they become wrinkled. **Remove the plastic vane insert from the fabric sleeve pocket before ironing the vane.** Iron the sheer fabric and the vane at level 2, or the "silk" setting on a household iron.

Soft Sheer Verticals can be ultrasonically cleaned.

XI TROUBLE SHOOTING

Problem: Sheer is wrinkled.

Repair: Remove wrinkles by steaming the sheer or by ironing. When steaming, the head of the steamer may come in contact with the sheer for up to 3 minutes. Iron the sheer at level 2 or the “silk” setting on a household iron.

Problem: Sheer looks wavy when vanes are in the open position.

Cause: Scotch-mate at the bottom of the vane is not set correctly.

Repair: Un-attach scotch-mate. Pull the sheer taut, **but not stretched** and re-attach scotch-mate. **Do Not over stretch sheer.**

Problem: When the vanes are closed, some vanes do not overlap at the bottom of the blind.

Cause 1: The vane insert is not seated fully in the carrier.

Repair 1: Make sure that the punch hole in the vane insert is fully engaged in the carrier.

Cause 2: Scotch-mate at the bottom of the vane is not set correctly.

Repair 2: Re-adjust Scotch-mate in the horizontal position. See Fabric Sleeve to Sheer bottom attachment of vane installation (Section **VII**).

Problem: The bottoms of the vanes are not lining up.

Cause: The vane is not seated fully in the carrier.

Repair: Make sure that the punch holes in the vane and in the vane insert are fully engaged in the carrier.

Problem: When the vanes are closed they slant.

Cause: The headrail is not level. 1. The inside mount mounting surface may not be level. 2. Wings nuts are not allowing the headrail to sit properly in the mounting clip. 3. Mounting clips slid out of position during bracket installation.

Repair 1: Level mounting surface with shims.

Repair 2: Place the wing nut up so that it does not interfere with the mounting clip.

Repair 3: Slide mounting clip as far forward as it will go in the bracket. The rivet used to attach the clip should be at the back of the slot in the clip.

Problem: Traverse cord is drooping from the track when the vanes are stacked.

Cause: Traverse cord is too long or Cord Tensioner is not set correctly.

Repair: Move cord tensioner down to create more tension or shorten traverse cord. See cord adjustment section (Section **V**) for instructions on adjusting cord length.

Stk. # 152026C

Rev. A

11/17/04